

# GENSET CONTROL MODULE—LEVEL 1

## A121CM / A241CM

### Features:

- Models for both 12V and 24V systems.
- One model for both spark ignition and diesel engines.
- 5-alarm light outputs with lamp-test provisions.
- Glow control pilot relay for engine pre-heat applications.
- User selectable time delay for engine stop (cool down).
- Loss of speed signal protection for crank motor circuit.
- Special logic to re-establish cranking following a false start.
- Special logic permits re-starting of hot engine.
- Pluggable terminal blocks for ease in installation.

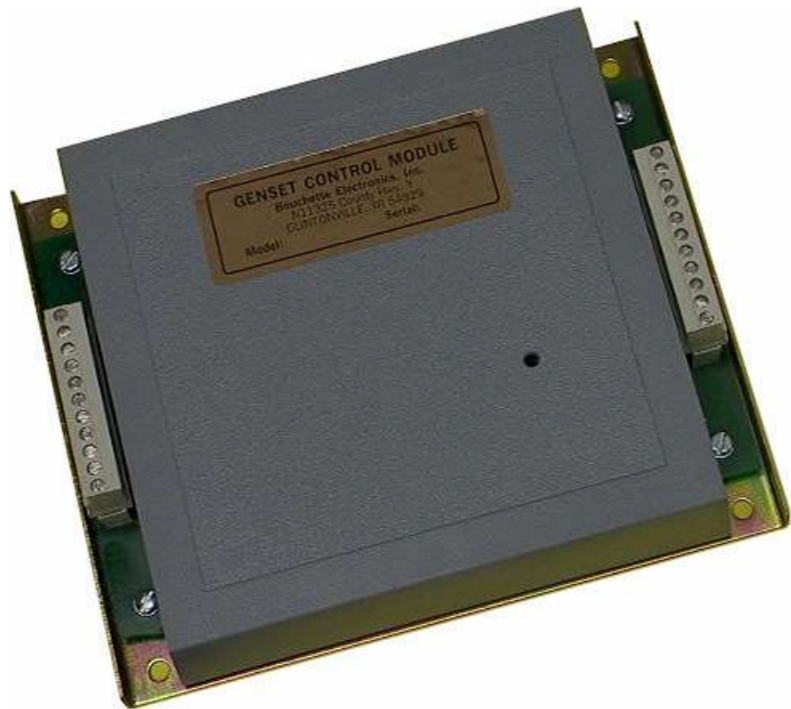

### General Description:

The Genset Control Module is a microprocessor based control system which provides complete automatic control of standby generator set engines. Fuel solenoid and/or ignition control, cranking control, and glow control are via heavy duty industrial type relay contacts. Engine temperature and oil pressure monitoring are obtained from engine mounted sensor contacts. Adjustable overspeed shutdown and crank termination control are provided internally via a frequency monitoring input terminal. This input signal may be obtained from any frequency source related to engine speed: distributor ignition pulses, magnetic pick-up, A.C. tachometer generator, alternator tachometer terminal, etc. One spare input and one spare output are available for special customer program requirements. Unless otherwise specified, this spare is shipped programmed as a 5th shutdown and alarm light output.

# Technical Data Sheet

## A121CM / A241CM Specifications

Input Voltage: Model A121CM: 12VDC nominal, 16VDC max; transient and reverse polarity protected. (Typical: Pickup at 10VDC, Dropout at 6VDC.)

Model A241CM: 24VDC nominal, 32VDC max; transient and reverse polarity protected. (Typical: Pickup at 14VDC, Dropout at 9VDC.)

Supply Current: 0.4A maximum plus alarm light burden.

Relay Load Contacts: FS & CS: 10A at 28VDC, inductive; AR: 2A at 28VDC, resistive.

Alarm Light Load: 150mA maximum each output (incandescent inrush is permitted.)

Shutdown Input Contacts: 3 (See operating instructions for start-up override times.)

Frequency Input: 80V RMS max. (See note 1.)

Overspeed trip point is adjustable from;

**A121CM:** 40 to 800Hz. (Ignition / Alternator Pick-up)

A121CM2 / **A241CM:** 350 to 1100Hz or 1750 to 5000Hz. (Alternator / Mag. Pick-up)

A121CM1 / A241CM1: 430 to 1350Hz or 2380 to 6800Hz. (Alternator / Mag. Pick-up)

Crank Disconnect Frequency: Internally fixed at 30% of the overspeed setting.

Crank Control: Cycle cranking: 5 cycles of 12 sec. crank and 12 sec. rest (non-adjustable.)

Time Delay (optional): Delay on shutdown from remote signal: 3 minutes (non-adjustable.)

Shielding: Internal EMI shielding provided.

Ambient Temperature: -25° F to +140° F

Finish: PC Board: Protected with moisture/fungus proof varnish.

Chassis: Zinc plated / yellow dichromate.

Cover: ABS plastic.

Terminal Blocks: Industrial vertical plug-in type header for ease in installation.

Note 1: Other models available for other frequencies and/or voltages.

Consult factory with your specific requirements.

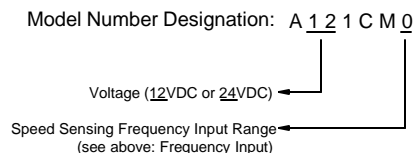

*Bouchette Electronics, Inc.*

N11325 County Highway Y, Clintonville, WI 54929  
(715) 823-7770 (715) 823-7771 Fax [www.bouchette.com](http://www.bouchette.com)

### A121CM / A241CM Dimensions

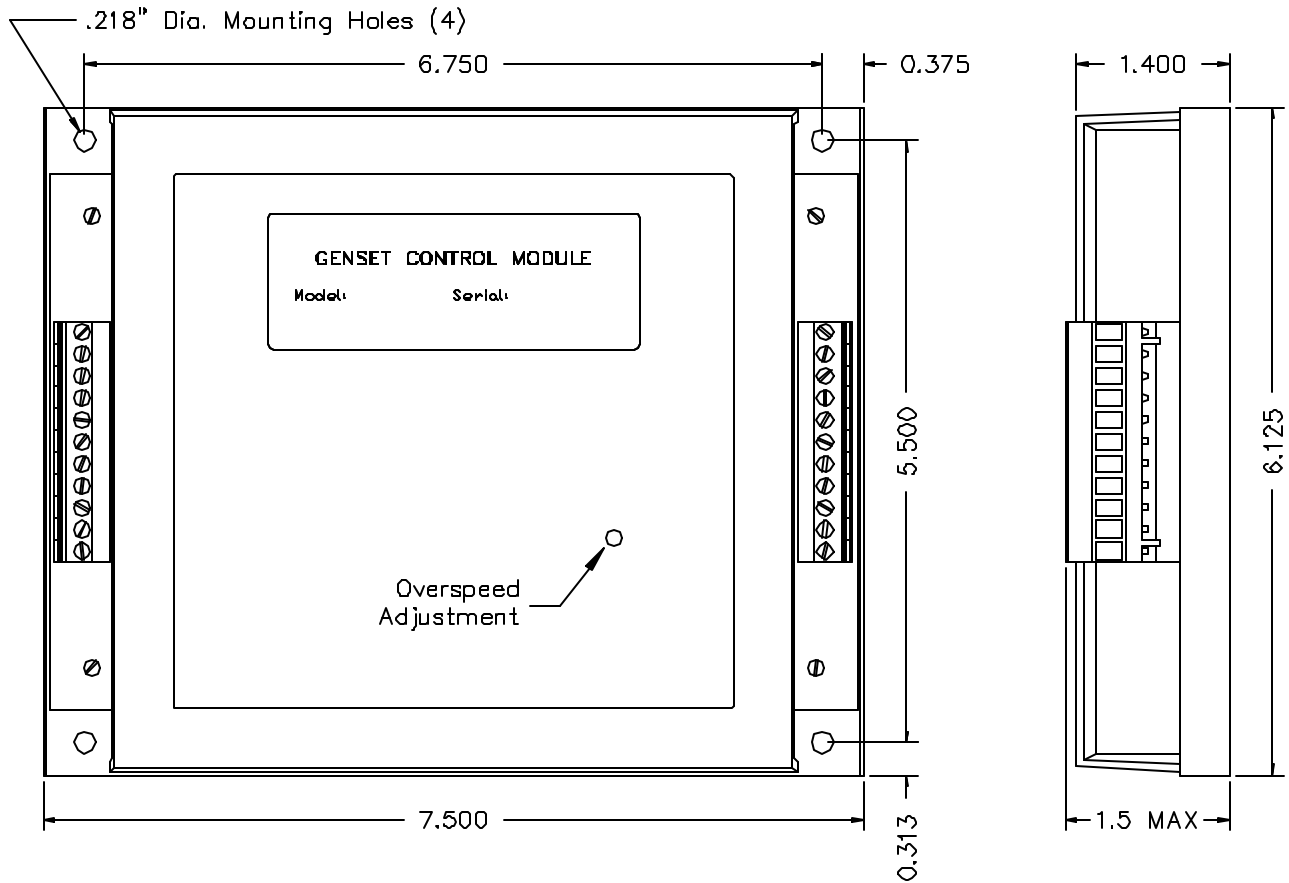

*Bouchette Electronics, Inc.*

N11325 County Highway Y, Clintonville, WI 54929  
(715) 823-7770 (715) 823-7771 Fax [www.bouchette.com](http://www.bouchette.com)

# GENSET CONTROL MODULE — LEVEL 1

## A121CM / A241CM

### Control Switch Inputs

The following operator panel controls are wired into the microprocessor through the front-mounted terminal blocks:

1. Run/Stop/Auto Switch.

a. “Run” position causes the engine to start and run immediately.

b. “Auto” position allows the unit to be controlled via any remote single-pole dry-type contact (transfer switch, remote start switch, etc.). Contact closure causes the unit to start and run, while contact opening causes the unit to shut down. *Also see Glow Cycle Select and Time Delay Select for time delay options.*

c. “Stop” position de-energizes the control module for immediate shutdown.

2. Lamp Test Push-Button.

Energizes all alarm lights simultaneously. This feature is disabled with the Run/Stop/Auto selector switch in the “Stop” position, and has no other effect on unit operation.

### Relay Functions

1. Master Control Relay (FS).

Operates the fuel solenoid, etc.

2. Cranking Control Relay (CS).

Controls engine cranking functions.

3. Glow Control Relay (AR).

Provides contact (2-amp. maximum) for pilot control of remote glow plug solenoid.

# Operating Instructions

## Safety Shutdown Inputs

### 1. Low Oil Pressure (LOP) Shutdown.

Monitoring of oil pressure begins 12-seconds after the unit starts and remains in effect until the unit is shut down (*except as noted in section Microprocessor Program Notes.*) Except as noted, closure of this contact while engine is running results in an engine fault shutdown with light indication. The LOP signal is derived from an oil pressure sensor switch mounted on the engine.

### 2. High Water Temperature (HWT) Shutdown.

The engine coolant temperature sensor monitoring begins immediately with the start signal. However, if the water temperature is excessive prior to start, (i.e., heat soak after shutdown), the unit is permitted to start and the high temperature condition is permitted to exist for up to 60-seconds after the unit is running, before an engine fault shutdown with light indication occurs. If the high temperature condition is corrected within that time period, the microprocessor circuit reverts to normal monitoring. Except as noted, closure of this contact while engine is running results in an engine fault shutdown with light indication. The HWT signal is derived from a temperature sensor switch mounted on the engine.

### 3. Low Fuel Level (LFL) Shutdown.

Monitoring of the fuel level input begins 12-seconds after the unit starts and remains in effect until the unit is shut down. Except as noted, closure of this contact while running results in an engine fault shutdown with light indication. The LFL signal is derived from a fuel level sensor switch mounted on the fuel tank.

### 4. Overspeed (OS) Shutdown / Adjustment.

Overspeed shutdown protection is provided by a frequency sensing network within the control module. The trip point of the frequency network is screwdriver adjustable through the opening in the face of the control module as shown. Clockwise rotation increases the trip frequency and thereby, raises the shutdown speed. Exceeding this speed will result in an engine fault shutdown with light indication.

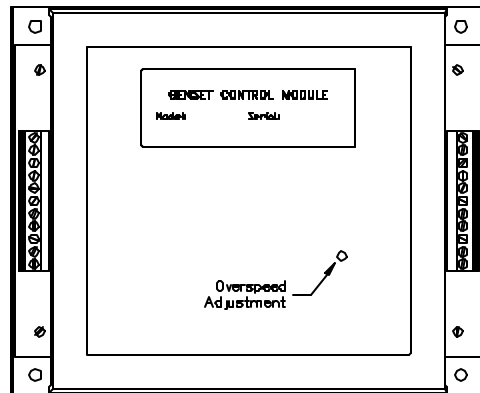

Genset Control Module—Face

## Cranking Control

### 1. Overcrank (OC) Protection.

This feature provides a series of five cranking cycles; each containing a 12-second crank period with a 12-second rest period. Failure of the engine to start by the end of the fifth crank period results in an “overcrank” engine fault shutdown with light indication.

### 2. Cranking Disconnect.

The cranking termination speed is obtained from the frequency network within the control module. The microprocessor automatically sets the cranking termination speed at 30% of the selected overspeed trip value.

### 3. Loss of Frequency Signal.

The microprocessor will detect an absence of frequency signal while cranking. After the first 12-seconds of cranking, the “overcrank” light begins a staggered flashing pattern to indicate there is no frequency signal input. Then the microprocessor automatically converts to a single-cycle cranking period, and an “overcrank” engine fault shutdown with light indication will occur at the end of 48-seconds. This conversion prevents the starter motor from re-engaging during the second crank cycle in the event the engine is already running. *Also see section Microprocessor Program Notes.*

## Time Delay Select

Cool-Down timing feature: The control module may be field-converted to include this feature by grounding the “TDI” terminal on the control. This feature will delay the shutdown of the engine for 3-minutes after the Remote Run contact is opened. This timing feature can be made active only in the “Auto” switch position. Placing the selector switch in the “Stop” position provides instantaneous shutdown of the engine under all conditions. The stop delay is intended to provide a cool-off running period for the engine after load removal.

## Glow Cycle Select

A glow plug cycle of 12-seconds can be introduced each time the engine is started by grounding the “CCI” terminal on the control module. The glow period energizes the glow plug pilot relay prior to cranking, therefore delaying startup of the engine for 12-seconds.

## Operating Instructions

### Microprocessor Program Notes

Internal protection against loss of frequency input signal is programmed in after the unit has started normally. In the event the frequency goes to zero (engine runs out of fuel, frequency signal source fails, etc.), the LOP shutdown circuit is bypassed and a 12-second wait period is initiated. If the frequency returns within this time period, LOP monitoring resumes and operation continues normally. If frequency has not returned at the end of this time period, the engine oil pressure status is observed to determine whether the engine is actually running or stopped. If the engine has stopped, the cranking cycle will begin in an effort to re-start the engine. If the engine has not stopped (loss of input signal, etc.), the unit is shut down with an “overcrank” engine fault with light indication.



**Caution:** “Overcrank” indication can mean a loss of frequency input signal during the previous run period. Attempting to re-start the engine without any frequency input signal can destroy the starter motor, which can cause serious personal injury. The frequency signal source is a key component in this system and must be checked out thoroughly whenever an “overcrank” shutdown occurs, since the control module only provides an indication of loss of signal during startup.

### Resetting A Fault Shutdown

A shutdown with alarm light indication, due to any fault condition, will prevent any subsequent operation of the generator set. The Run/Stop/Auto selector switch on the operator control panel must be momentarily placed in the “Stop” position to reset these functions.

*Bouchette Electronics, Inc.*

N11325 County Highway Y, Clintonville, WI 54929  
(715) 823-7770 (715) 823-7771 Fax [www.bouchette.com](http://www.bouchette.com)

## GENSET CONTROL MODULE—LEVEL 1 & 2

# Overspeed Selection Formula

**The Genset manufacturer must determine the overspeed (OS) trip point based on maximum allowable speeds for both the engine and generator.**

**The following formula should be used to determine the OS trip frequency for any engine<sup>1</sup>. Select a Genset Control model which OS frequency range includes the desired trip frequency.**

- 1) All engines with magnetic pick-up sensing (*recommended*):

$$\text{OS Frequency} = 30 \times D \times (\text{number of teeth on ring gear})$$

- 2) All engines with belt-driven alternator sensing:

$$\text{OS Frequency} = 15 \times D \times (\text{number of alt. poles}) \times \frac{(\text{drive pulley diameter})}{(\text{alt. pulley diameter})}$$

- 3) All engines with flywheel-type alternator sensing:

$$\text{OS Frequency} = 15 \times D \times (\text{number of alternator poles})$$

- 4) Gasoline engines only, with distributor ignition sensing:

$$\text{OS Frequency} = 15 \times D \times \text{number of cylinders}$$

**D = Speed Multiplier**

i.e. If OS is set at @ 72Hz (on 60Hz generator),  
then D = 1.2 (1.2 × 60Hz = 72Hz)

<sup>1</sup>These formulae are for nominal 1800 RPM engines; for 3600 RPM engines, the calculated OS frequency should be doubled.

*Bouchette Electronics, Inc.*



# GENSET CONTROL MODULE—A121\_ / A122\_ Overspeed Set-Up Instructions



**Before installing the Genset Control Module, the proper input frequency range needs to be selected as described below.**

Through a hole in the back of each control (as shown in diagram below), jumper wire(s) are used to select the input frequency range. Locate your model number on the following charts for the correct range settings.

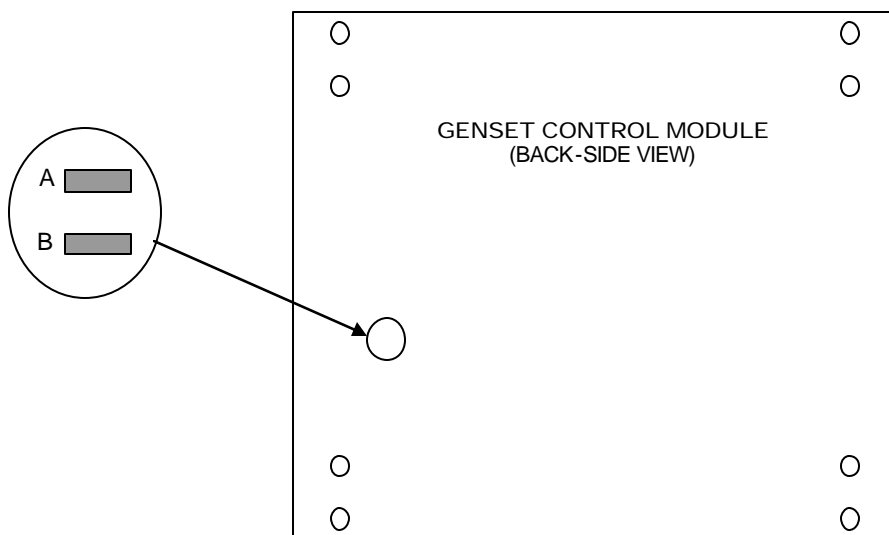

**Caution:** When cutting jumper wires, do not allow ends of jumper wire to come in contact with other components or the chassis. Completely remove the jumper wire, or cut in the middle and separate ends about 1/8".

*Bouchette Electronics, Inc.*

N11325 County Highway Y, Clintonville, WI 54929  
(715) 823-7770 (715) 823-7771 Fax [www.bouchette.com](http://www.bouchette.com)

## Important Notice

# OVERSPEED MODEL SELECTION—A121\_ / A122\_

<u>Available Models</u>	
<b>A121AM1 A121BM1 A121CB1</b>	
<b>A121CM1 A121M1 A121S1</b>	
<b>A241AM1 A241BM1 A241CM1</b>	
<u>Typical Frequency Input Sources</u>	
Magnetic Pick-up Alternator tachometer terminal Tachometer generator	
At engine overspeed, the Input Frequency is between:	Cut these Jumper Wires
430 - 1350 Hz	None
2380 - 6800 Hz	"A" Only

<u>Available Models</u>	
<b>A121AM1 A121BM2 A121CB2</b>	
<b>A121CM2 A121M2 A121S2</b>	
<b>A241AM A241BM A241CM</b>	
<u>Typical Frequency Input Sources</u>	
Magnetic Pick-up Alternator tachometer terminal Tachometer generator	
At engine overspeed, the Input Frequency is between:	Cut these Jumper Wires
350 - 1100 Hz	None
1750 - 5000 Hz	"A" Only

<u>Available Models</u>	
<b>A121AL A121AM A121AX A121BM A121CB</b>	
<b>A121CD A121CL A121CLM A121CM A121CX</b>	
<b>A121E0M A121M A122E0M</b>	
<u>Typical Frequency Input Sources</u>	
Alternator tachometer terminal Distributor low-voltage input terminal	
At engine overspeed, the Input Frequency is between:	Cut these Jumper Wires
28 - 90 Hz	None
78 - 240 Hz	"A" Only
200 - 600 Hz	"B" Only
250 - 800 Hz	"A" and "B"

*Bouchette Electronics, Inc.*

N11325 County Highway Y, Clintonville, WI 54929  
(715) 823-7770 (715) 823-7771 Fax [www.bouchette.com](http://www.bouchette.com)

### GENSET CONTROL MODULE

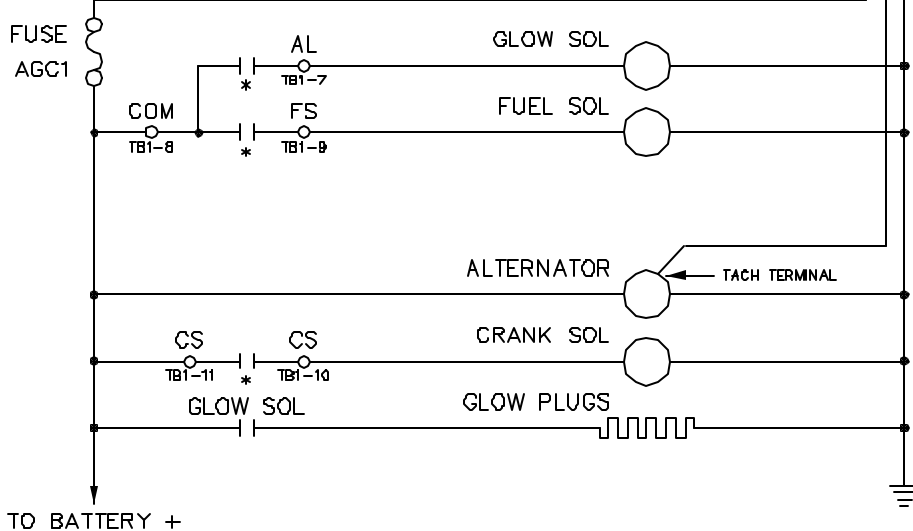
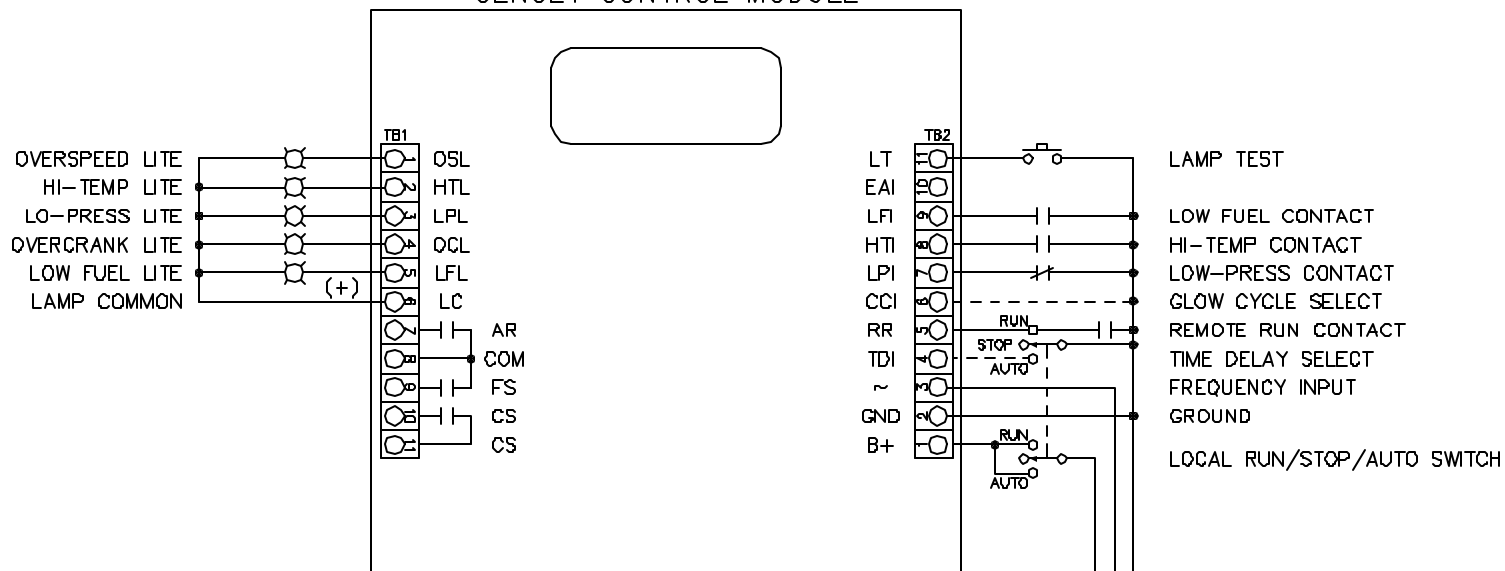

\* RELAYS FS, CS,  
& AR ARE INSIDE  
THE GENSET CONTROL

FREQUENCY SENSING FROM ALTERNATOR TACH. TERMINAL

<b>Bouchette Electronics, Inc.</b> N11325 County Highway Y Clintonville, WI 54929			
TITLE CONNECTION DIAGRAM A121CM/A241CM CONTROL			
DATE	DWN BY	CHK	SCALE
12/13/95	DSB	TJB	NONE
P/N	CAD REF	DWG NO	
	PCB107	E151-9	